



SME
Cloud Promotion Campaign
雲端趨勢 • 無限商機

政府「中小企雲端應用推廣計劃」之 「物流行業」培訓講座

物流業雲端應用推廣講座系列(四之一)

應用雲端無難度 物流效率齊提高



政府資訊科技總監辦公室
Office of the Government Chief Information Officer



講員: 歐慶華 Louie (MSc (e-Commerce for Executives), BBus)

Speaker – Louie AU

- MSc (E-Com for Executives), BBus (Computing), Sr Certified E-Business Specialist 高級商業電子商務師
- Independent Professional Consultant
- 20+ years experience in
 - I.T.
 - Consultancy
 - E-commerce
 - Management
 - Business Development
 - Training & Education
 - Project Management
- la9168@gmail.com
- <http://www.linkedin.com/in/businessconsultantlouie>
- (852) 64381091 / (86) 15217940391



物流業雲端應用推廣講座 (共四講)

第一講

1. 雲端運算介紹
2. 雲端運算模型介紹
3. 物流及運輸業的特質及對雲端服務的需要
4. 雲端運算為物流及運輸業帶來的好處及例子

第二講

1. 物流及運輸業的中小企業應用雲端運算的好處
2. 中小企業應用雲端運算的考慮因素及技術挑戰

第三講

1. 如何選擇不同的雲端方案及雲端方案比較
2. 物流及運輸業應用雲端服務的成功因素及注意事項

第四講

1. 物流及運輸業應用雲端服務的成功案例分享
2. 行業雲端方案介紹

物流業雲端應用推廣講座 (共四講)

第一講

1. 雲端運算介紹
2. 雲端運算模型介紹
3. 物流及運輸業的特質
4. 物流及運輸業對雲端服務的需要
5. 雲端運算為物流及運輸業帶來的好處
6. 物流及運輸業的雲端方案例子
7. 小結



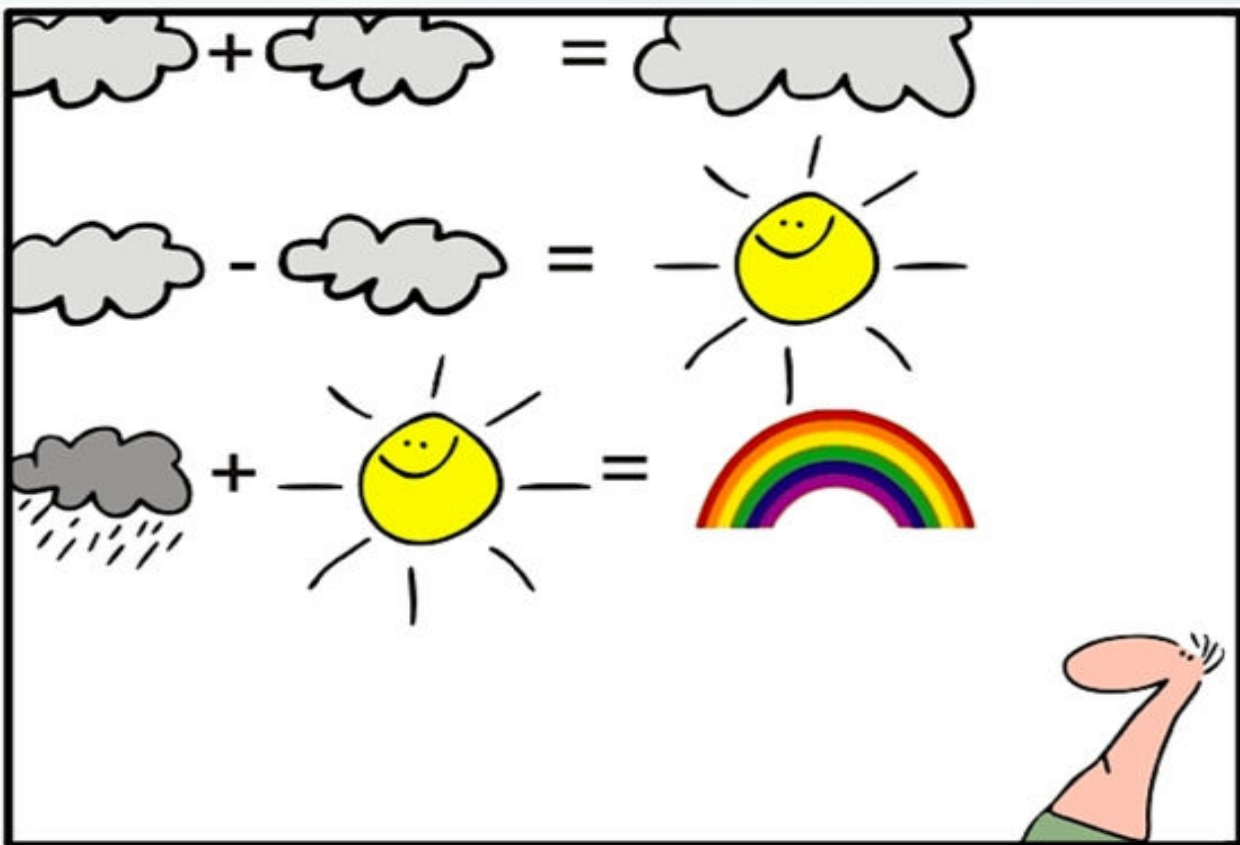

geek and poke

SIMPLY EXPLAINED - PART 17: CLOUD COMPUTING

1. 雲端運算介紹

a. 甚麼是雲端和雲端運算

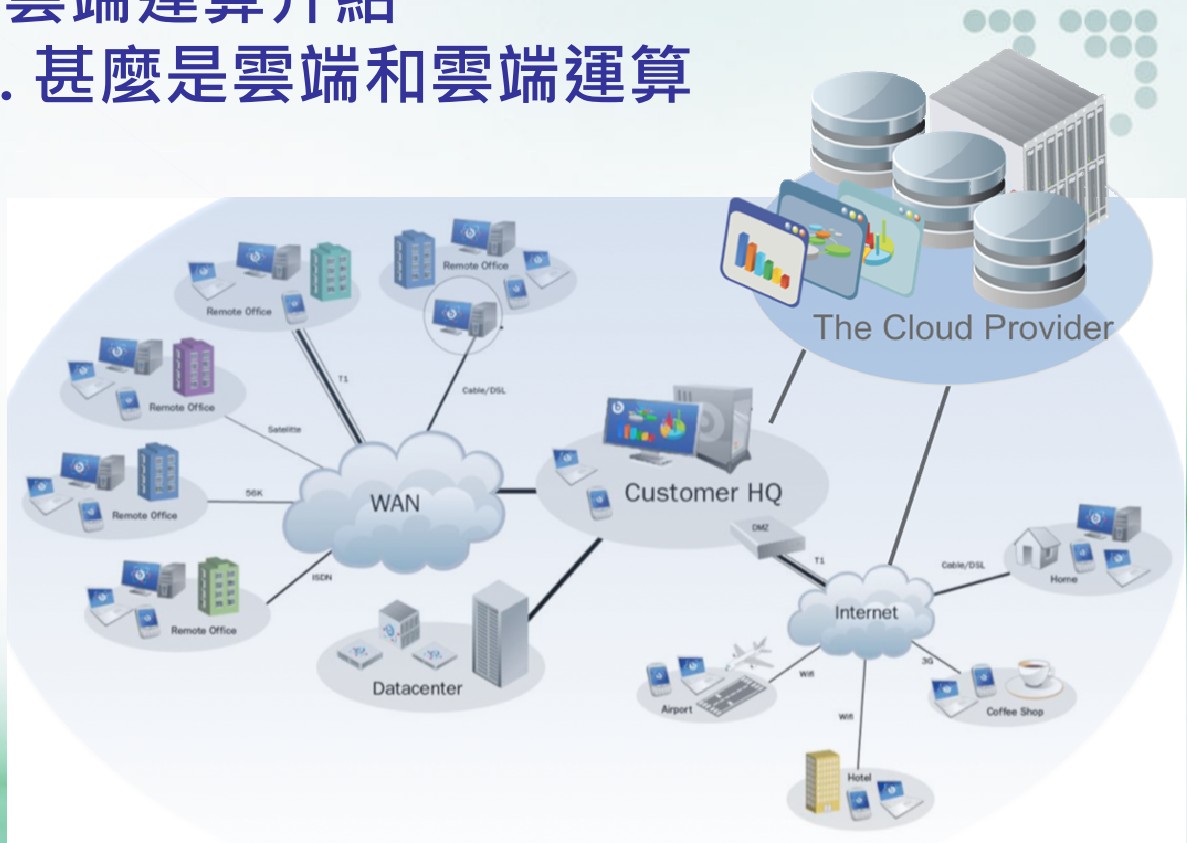

1. 雲端運算介紹

a. 甚麼是雲端和雲端運算 (1)

- 雲端 ≠ 互聯網 (Cloud ≠ Internet)
- 雲端可理解為於互聯網上的多台電腦 (伺服器) 組合。
- 分散式運算 (Distributed Computing) 的新運用
- 透過互聯網將龐大的運算處理程序 (Process) ，自動分拆成無數個較小的子程序 (Sub process) ，再交由多部伺服器 (Multi- Server) 所組成的龐大系統，透過搜尋與運算分析之後，再將處理結果回傳給使用者端。
- 服務供應商 (Service Provider) 可以在數秒之內，處理數以千萬計甚至億計的資訊。



1. 雲端運算介紹

a. 甚麼是雲端和雲端運算 (2)

- 達到和「超級電腦」同樣強大效能的網路服務。
- 是讓網路上不同電腦同時幫你做一件事情，大幅增進處理速度。
- 最終目標是沒有軟體的安裝，使用者運用網路服務來完成事情的方式。
- 所有的資源都來自於雲端，使用者端只需一個連上雲端的設備與簡單的介面 (例如瀏覽器) 即可。
- <http://www.youtube.com/watch?v=Z5f2FQkLfd0>



1. 雲端運算介紹

b. 雲端運算的起源

- 60年代已開始研究開發，近年更因 Web 2.0 而發展更快和成熟。
- 1999 Salesforce.com
- 2002 Amazon Web Services (AWS)
- 2006 Amazon Elastic Compute Cloud (EC2)
- 2009 Google 提供 browser-based enterprise applications (Google Apps)

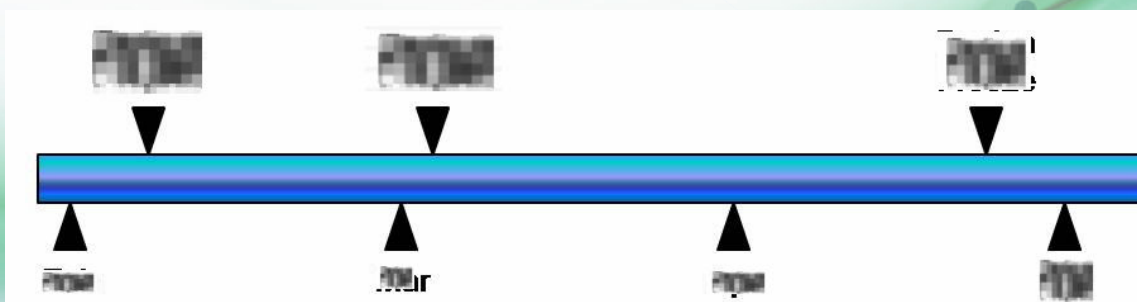

1. 雲端運算介紹

c. 雲端運算與傳統 I.T. 的比較

- 傳統 I.T. 於機構內的部件



1. 雲端運算介紹

c. 雲端運算與傳統 I.T. 的比較

- 結構的比較

傳統 I.T. 結構

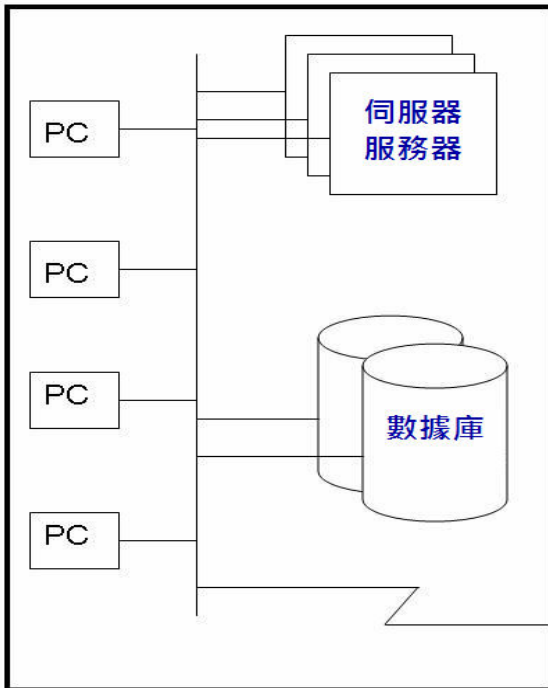

雲結構

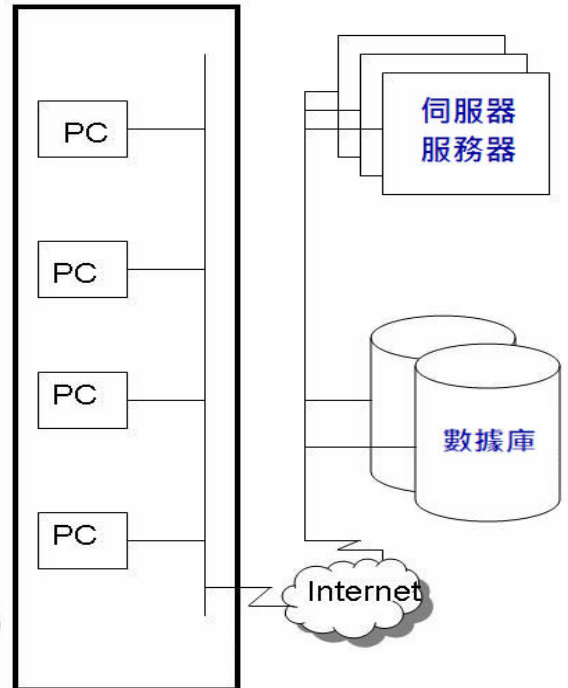

1. 雲端運算介紹

d. 雲端運算的特色 (1)



廣泛而方便地連接系統(雲系統)



快速而有彈性地增加資源
來應對需求的突增

1. 雲端運算介紹

d. 雲端運算的特色 (2)



按需自助式



按量收費

1. 雲端運算介紹

d. 雲端運算的特色 (3)

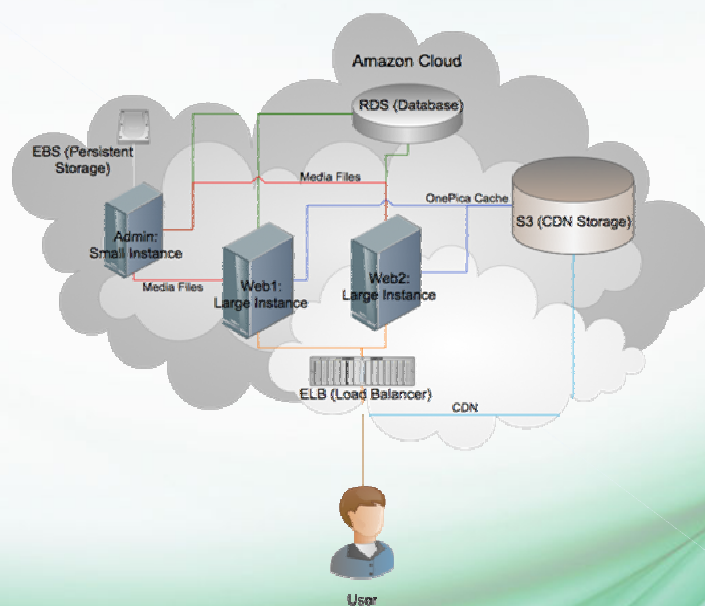

用家端能於任何地方使用雲端的資源
雖雲端上的資源是分散在供應商不同地方的系統中
但於用家來說是一個無縫的資源整體

1. 雲端運算介紹

d. 雲端運算的特色 (3a)

- AWS 的全球雲端運算中心



1. 雲端運算介紹

d. 雲端運算的特色 (4)

- I.T. 需要與 I.T. 產能 (a)

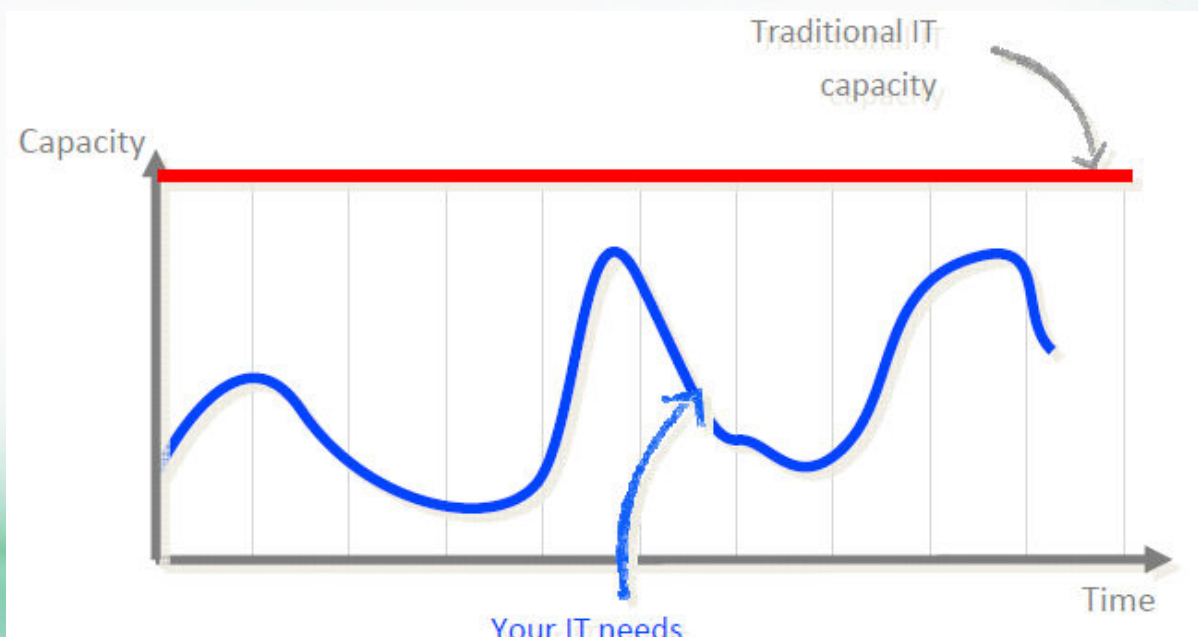

1. 雲端運算介紹

d. 雲端運算的特色 (4)

- I.T. 需要與 I.T. 產能 (b)

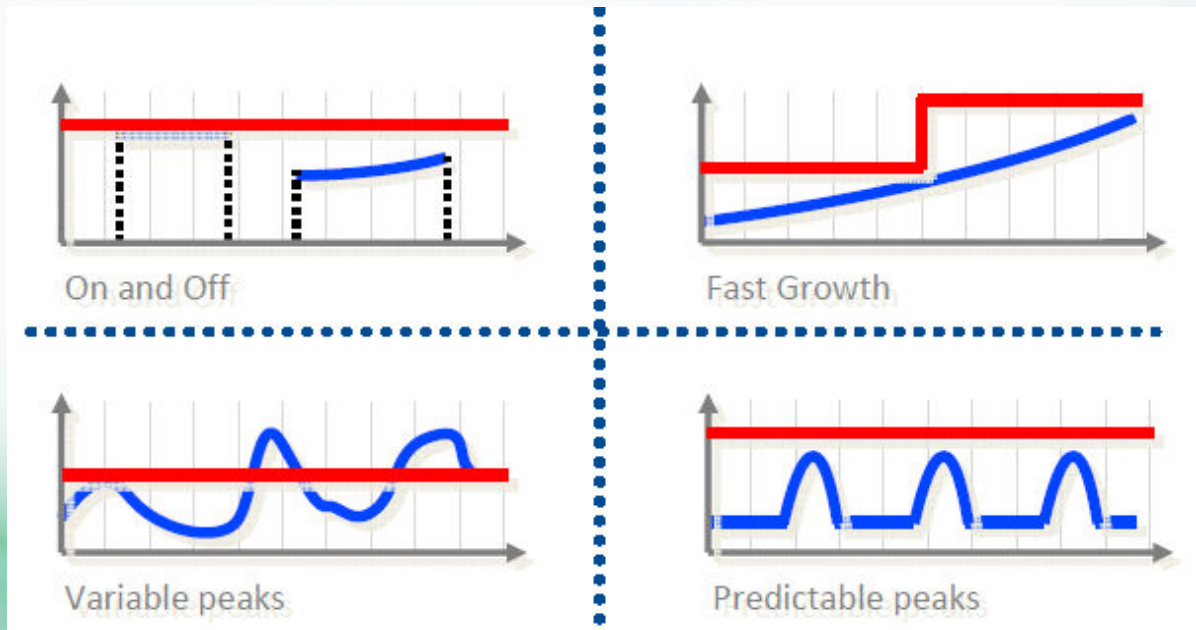

1. 雲端運算介紹

d. 雲端運算的特色 (4)

- I.T. 需要與 I.T. 產能 (c)

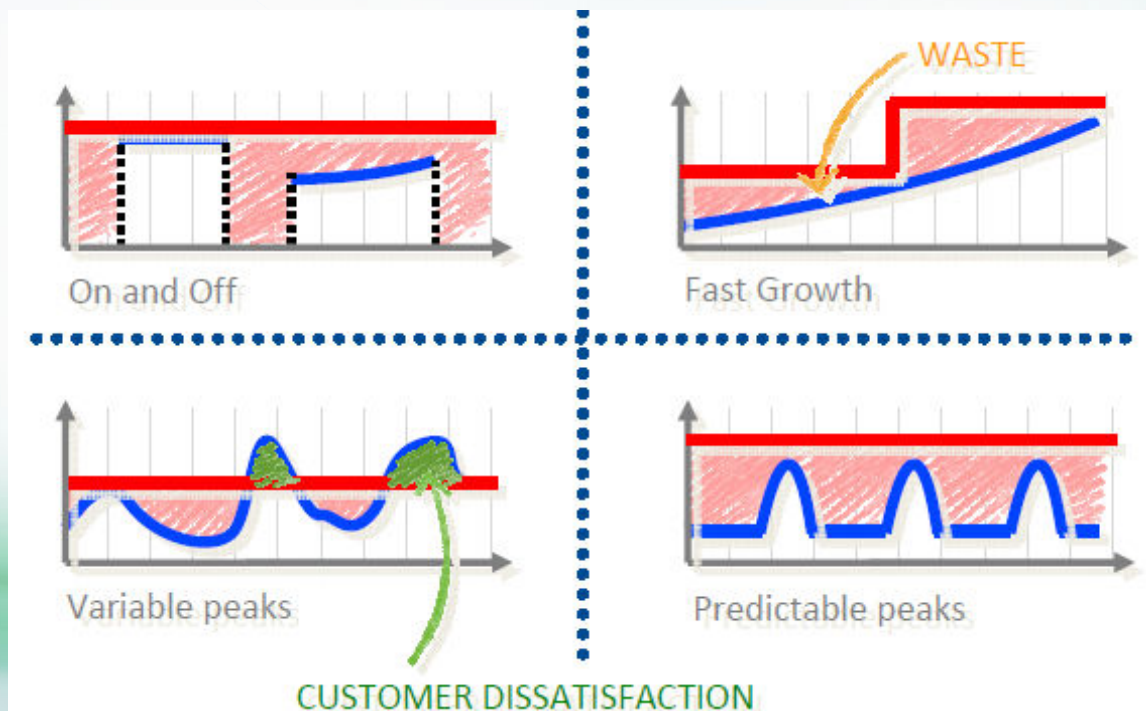

1. 雲端運算介紹

d. 雲端運算的特色 (4)

- I.T. 需要與 I.T. 產能 (d)

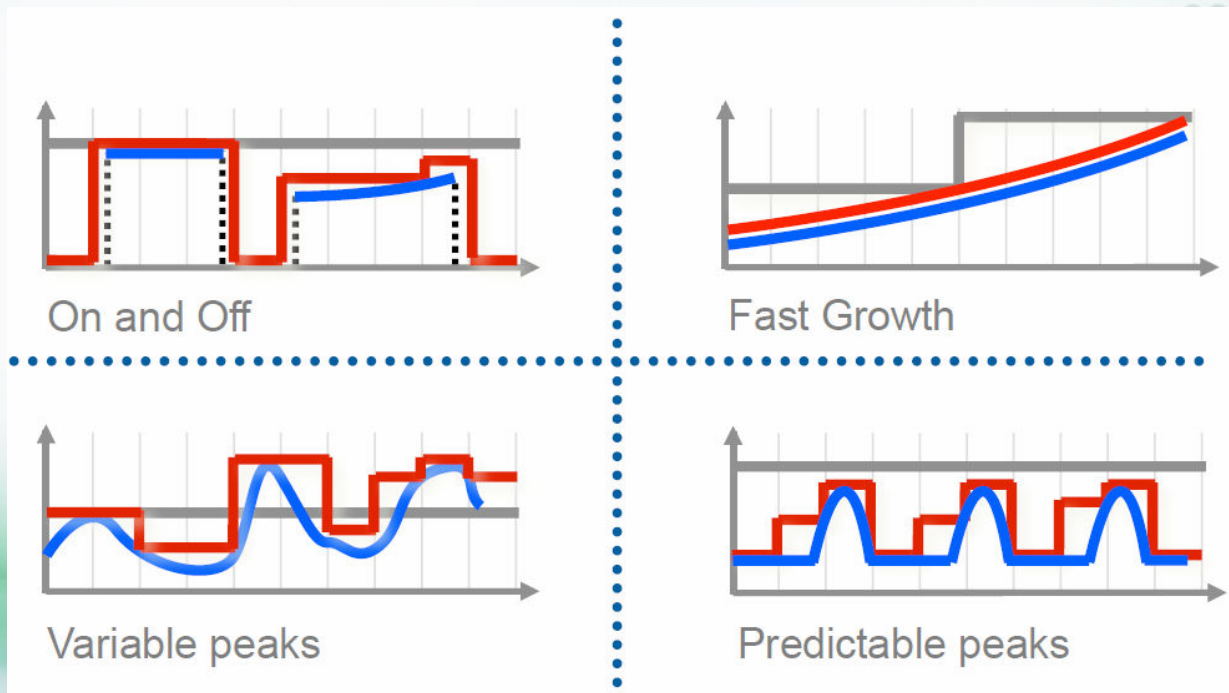

2. 雲端運算模型簡介

a. 雲端運算的服務模型

i. 基礎設施即服務 (IaaS)

- Infrastructure-as-a Service
- 包含硬體和底層軟體
- 提供獨立 IP 和實質儲存體
- 建構成虛擬伺服器 (Virtual Private Server)，使用者像擁有伺服器般來作日常運作。
- (Virtualization) 虛擬化
- 把記憶體、I/O 裝置、儲存和運算能力集中形成虛擬的資源中心 (即虛擬伺服器)，來提供服務。
- 費用以其使用量或設置支付
- 例子：New York Times using Amazon EC2



2. 雲端運算模型簡介

a. 雲端運算的服務模型

i. 基礎設施即服務 (IaaS) 例子



The screenshot displays the AWS website's 'AWS Free Tier' section. It features the Amazon Web Services logo at the top left, with navigation links for 'Sign Up', 'My Account / Console', and 'English'. Below the logo is a search bar and navigation menus for 'AWS Products & Solutions', 'Entire Site', 'Developers', and 'Support'. The main content area highlights the 'AWS Free Tier' with the text: 'Launch new applications, test existing applications in the cloud, or simply gain hands-on experience with AWS.' and a link to 'Get started with AWS for Free'. To the right, three service categories are listed: 'Compute' (Amazon EC2, 750 hours/month*), 'Storage' (Amazon S3, 5 GB*), and 'Database' (DynamoDB, 100 MB of SSD-backed storage*). A prominent yellow button says 'Get Started for Free' with the text 'Launch virtual machines and apps in minutes.' Below this are three cards: 'WHAT IS CLOUD COMPUTING?', 'AWS FREE TIER', and 'START-UPS ON AWS'.

2. 雲端運算模型簡介

a. 雲端運算的服務模型

ii. 平台即服務 (PaaS)

- Platform-as-a Service
- 於供應商平台上，提供一系列開發軟件。
- 開發員可於其上開發和編寫軟件
- 一般而言，相對傳統的軟件開發系統或平台，PaaS 需要支援各種 SaaS 服務，所以它必須具備良好的靈活性和可擴充性。
- 同時，它要支援大量的線上使用者，因此它亦需要更高的穩定性。
- 例子：**Salesforce.com**、**facebook** 和 **GoogleApps**、**MIT App Inventor**



2. 雲端運算模型簡介

a. 雲端運算的服務模型

ii. 平台即服務 (PaaS) 例子



The screenshot shows the Windows Azure portal interface. The top navigation bar includes 'ACCOUNT', 'PORTAL', and a search icon. Below this, there are links for 'SOLUTIONS', 'PRICING', 'DOCUMENTATION', 'DOWNLOADS', 'ADD-ONS', 'COMMUNITY', and 'SUPPORT'. A 'FREE TRIAL' button with a right-pointing arrow is also visible. The main content area is titled 'Cloud Services' and describes the benefits of using Azure Cloud Services, such as high availability, scalability, and ease of deployment. A left-hand navigation menu lists various services under categories like 'Compute', 'Data Services', and 'App Services'. The 'Cloud Services' item in the menu is highlighted in green.

2. 雲端運算模型簡介

a. 雲端運算的服務模型

ii. 平台即服務 (PaaS) 例子 <https://developers.facebook.com/>



The screenshot shows the Facebook Developers 'Start' page. The top navigation bar includes 'Developers', 'My Apps', 'Products', 'Docs', 'Tools & Support', and 'News'. A search bar is located on the right. The main content area features a large blue banner with the text 'Join Our Global Startup Program' and 'Free tools, mentorship, events, and community'. A 'Learn More' button is positioned below the banner. Below the banner, there are icons for 'Login', 'Sharing', 'Parse', 'Games', 'App Ads', and 'Payments'. At the bottom, there is a section titled 'Get more installs' with the text 'Grow your app and get more installs with mobile app install ads and engagement ads' and a 'Learn More' button. To the right of this text are icons for the Google Play Store, a target icon, and the Apple App Store.

2. 雲端運算模型簡介

a. 雲端運算的服務模型

ii. 平台即服務 (PaaS)

- MIT App Inventor (appinventor.mit.edu/explore)

The screenshot shows the MIT App Inventor website. At the top, there is a navigation bar with 'About', 'News & Stories', and 'Resources' menus, and a 'Create' button. Below the navigation bar, there are social media links for Facebook, Twitter, YouTube, and Google+. A search bar is also present. The main content area features a large banner with the text 'Your ideas. Your designs. Your apps.' and a prominent 'Invent Now' button. To the left of the banner, there are statistics: 'Weekly Active Users: 91K', 'Total Registered Users: 2.7M', 'Countries: 195', and 'Apps Built: 7.1M'. Below the banner, there is a section for 'Get Started' with a 'Start' button, 'Tutorials' with a 'Tutorials' button, 'Teach' with a 'Teachers, find out about curriculum and teaching' link, and 'Forums' with a 'Join community forums to get answers to your' link. On the right side, there is a 'Recent News' section with several news items and a 'Tweets' section with two tweets from Pat Yongpradit and Tapera Musungwa.

2. 雲端運算模型簡介

a. 雲端運算的服務模型

iii. 軟件即服務 (SaaS)

- Software-as-a Service
- 供應任何網上應用軟件
- 軟體服務的傳遞方式，使用者只需要向廠商訂購該服務，不需要佈署資訊系統，也不需要支付軟體授權金，就能使用該軟體的服務。
- 例子：**Gmail**和**facebook**



2. 雲端運算模型簡介

a. 雲端運算的服務模型

iii. 軟件即服務 (SaaS) 例子



The screenshot shows the Google Drive web interface. At the top, there is a Google search bar and user profile information. Below that, the Drive header includes a 'Drive' label, a 'Take our survey!' link, and sorting options. A 'CREATE' dropdown menu is open on the left, listing options: Folder, Document, Presentation, Spreadsheet, Form, Drawing, and 'Connect more apps'. The main content area features a 'Meet your Drive' section with a 'Download Google Drive for PC' button and a list of files. The file list has columns for 'TITLE', 'OWNER', and 'LAST MODIFIED'. One file is visible: '2.mpg Shared' owned by 'me' and last modified on 'Oct 26 me'. At the bottom left, storage usage is shown as '0.36 GB (2%) of 15 GB used' with a 'Manage' link.

2. 雲端運算模型簡介

a. 雲端運算的服務模型

iii. 軟件即服務 (SaaS) 例子



The screenshot shows the Salesforce website homepage. The top navigation bar includes the Salesforce logo, contact numbers for Singapore, Hong Kong, and International, a search bar, and buttons for 'Login' and 'Free Trial'. Below the navigation bar is a main banner with the text 'Introducing One Customer Platform to connect everything.' and the Salesforce logo. To the right of the banner are three call-to-action buttons: 'Free trial >', 'View demo >', and 'Up to 100 Employees? >'. Below the banner is a horizontal menu with four categories: 'Sales', 'Service', 'Marketing', and 'Platform'. At the bottom, there is a section for 'salesforce | Service Cloud' with the tagline 'FASTER SERVICE WITH THE WORLD'S #1' and a collage of user avatars.

2. 雲端運算模型簡介

a. 雲端運算的服務模型

iii. 軟件即服務 (SaaS) 例子

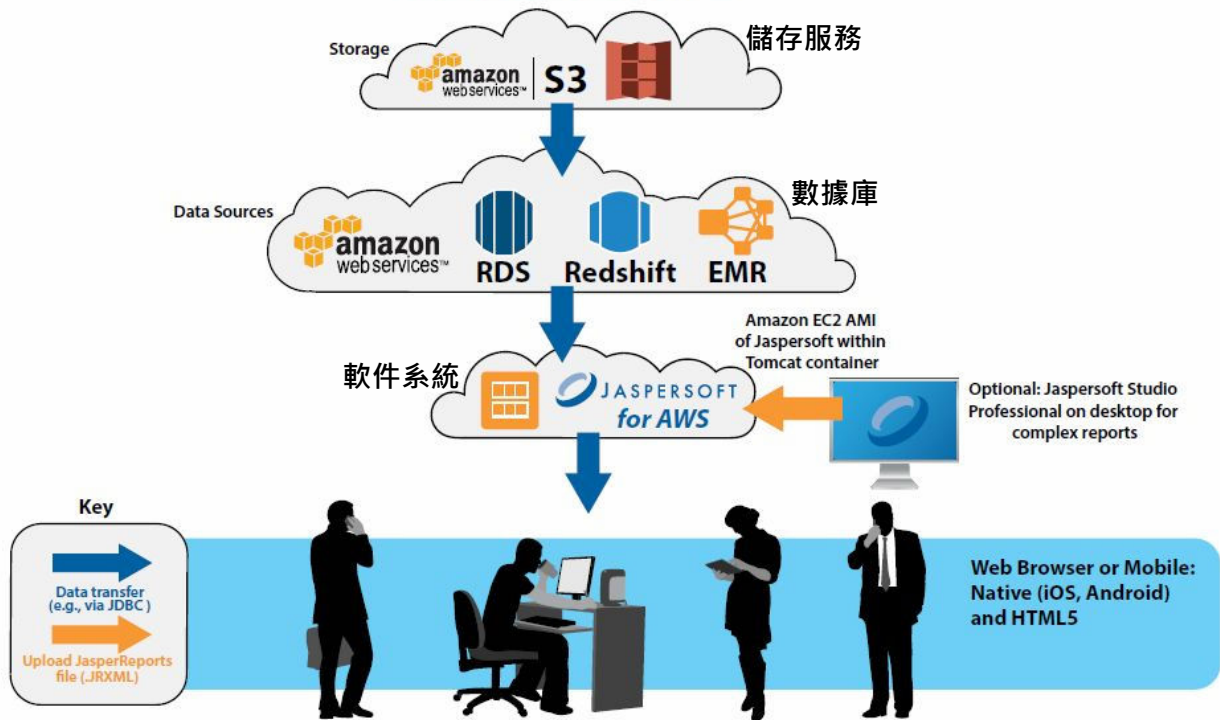

2. 雲端運算模型簡介

a. 雲端運算的服務模型比較 (1)

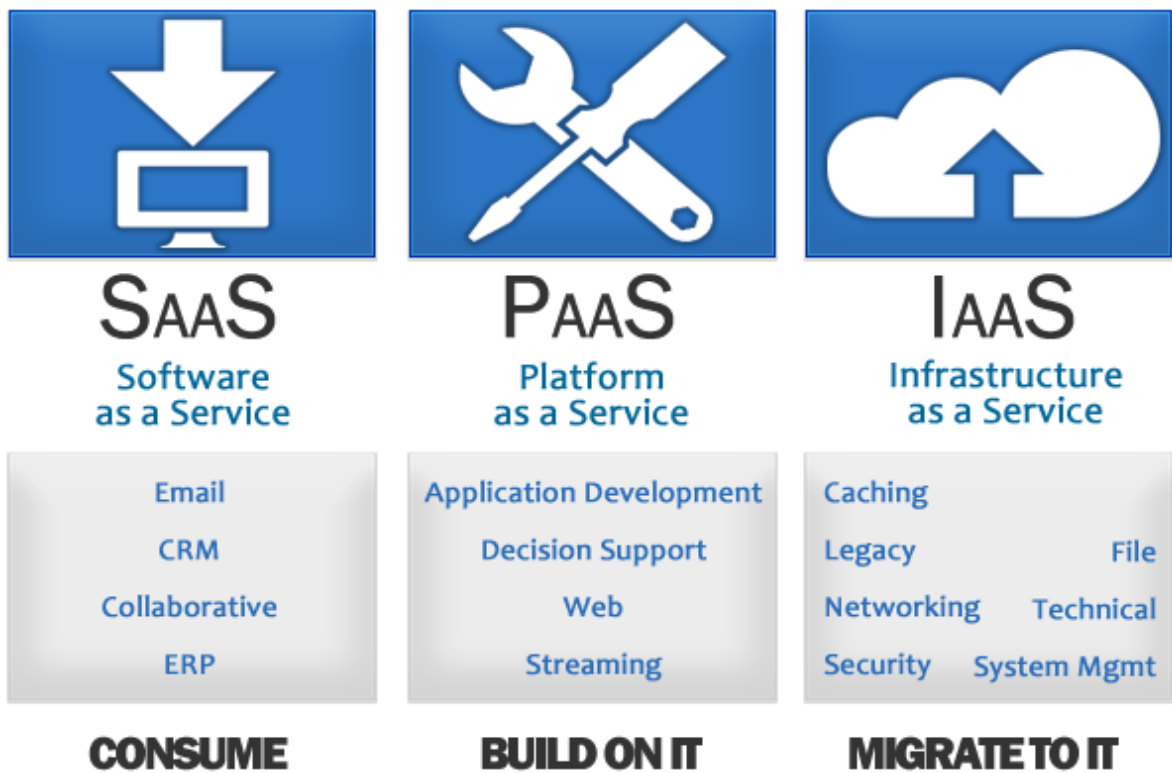

2. 雲端運算模型簡介

a. 雲端運算的服務模型比較 (2)



2. 雲端運算模型簡介

a. 雲端運算的服務模型比較 (3)

• 微軟的雲架構



2. 雲端運算模型簡介

b. 四個雲端運算的部署模型

i. 私有雲 (Private Cloud)

- 由一個企業所擁有，一般只有此企業或其客戶可使用該服務。
- 有強的隔離性
- 更安全但成本高
- 部署方式靈活
- 服務質量較高
- 更有效的控制



2. 雲端運算模型簡介

b. 四個雲端運算的部署模型

ii. 公用雲 (Public Cloud)

- 供公眾使用
- 由大型企業提供雲端運算服務
- 將個人數據從私人電腦轉移到公開式的雲運算上
- 由於其開放性之故，安全性相對地較低。
- 成本較低，免費或按量收費。
- 彈性大，可按個人需要而使用不同的應用程式。
- 例: AWS & Google Drive

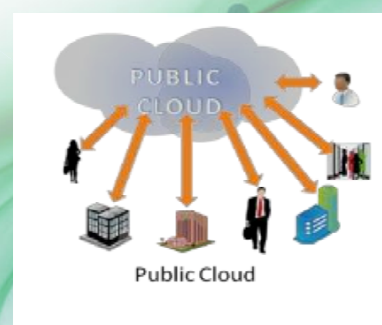

2. 雲端運算模型簡介

b. 四個雲端運算的部署模型

iii. 社群雲〈Community Cloud〉

- 由兩個或以上的機構所擁有及使用，一般有共同關心的事或共同目標，亦可能是有密切關係。
- 多為非牟利方式營運
- 如不同的大學學系(同校的)



2. 雲端運算模型簡介

b. 四個雲端運算的部署模型

iv. 混合雲〈Hybrid Cloud〉

- 顧名思義，此為上三種模型的混合體。
- 重點是怎去平衡各模型的優劣勢



3. 物流及運輸業的特質

a. 物流的七項功能要素 (1)

- 基本功能



3. 物流及運輸業的特質

a. 物流的七項功能要素 (2)

- 關注重點



配送



3. 物流及運輸業的特質

a. 物流的七項功能要素 (3)

- 輔助并技術性強

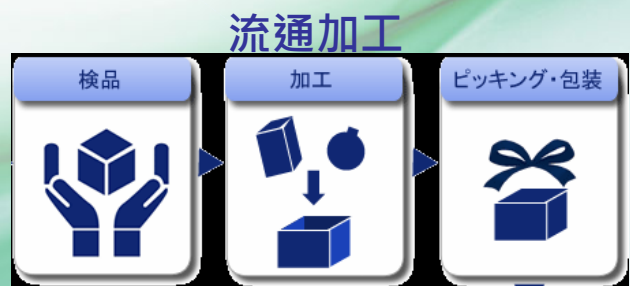

3. 物流及運輸業的特質

b. 行業特質 (1)

- 要求以下操作參數的準確度或緊迫度都要高
 - 時間
 - 地點
 - 人 / 單位
 - 數量 / 量度單位

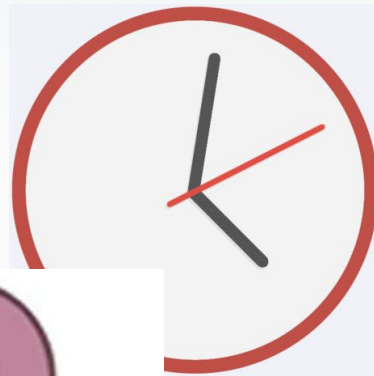

3. 物流及運輸業的特質

b. 行業特質 (2)

- 7 x 24 x 365
- 由於行業涉及大量的戶外操作，或甚暴露於極端環境之下。因此其不確定性大增，突發事件及意外時有發生。
- 大自然及環境因素對行業有很大的影響 (如天氣)。
- 高流動性及機動性



4. 物流及運輸業對雲端服務的需要

- 實時性 (即時性)
- 排程功能
- 系統需具開放性
 - 能跟其他系統兼容和互動，數據亦可互相傳輸。
- 高效能地處理大量數據
 - 數據的輸出輸入
 - 數據的傳輸
- 強大預報及運算功能

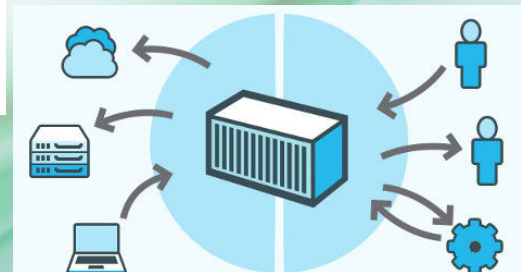
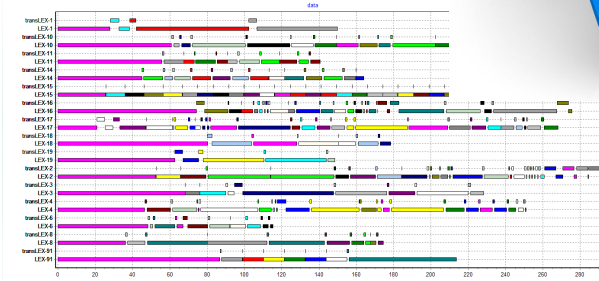

5. 雲端運算為物流及運輸業帶來的好處 (1)

- 節省資金成本
- 更新、升級更快速
- 經過驗證的網路服務整合
- 世界級的服務傳遞
- 不需安裝任何硬體和軟體
- 部署時速度更快，風險更低。
- 自動升級不影響 I.T. 資源

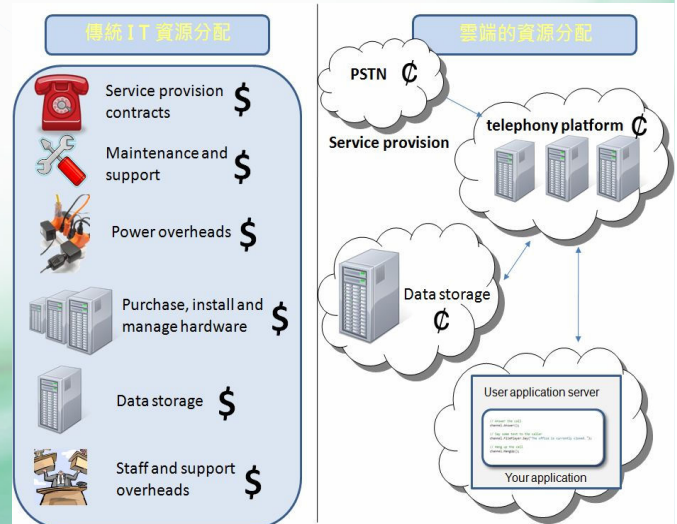

5. 雲端運算為物流及運輸業帶來的好處 (2)

- 節省內部管理成本

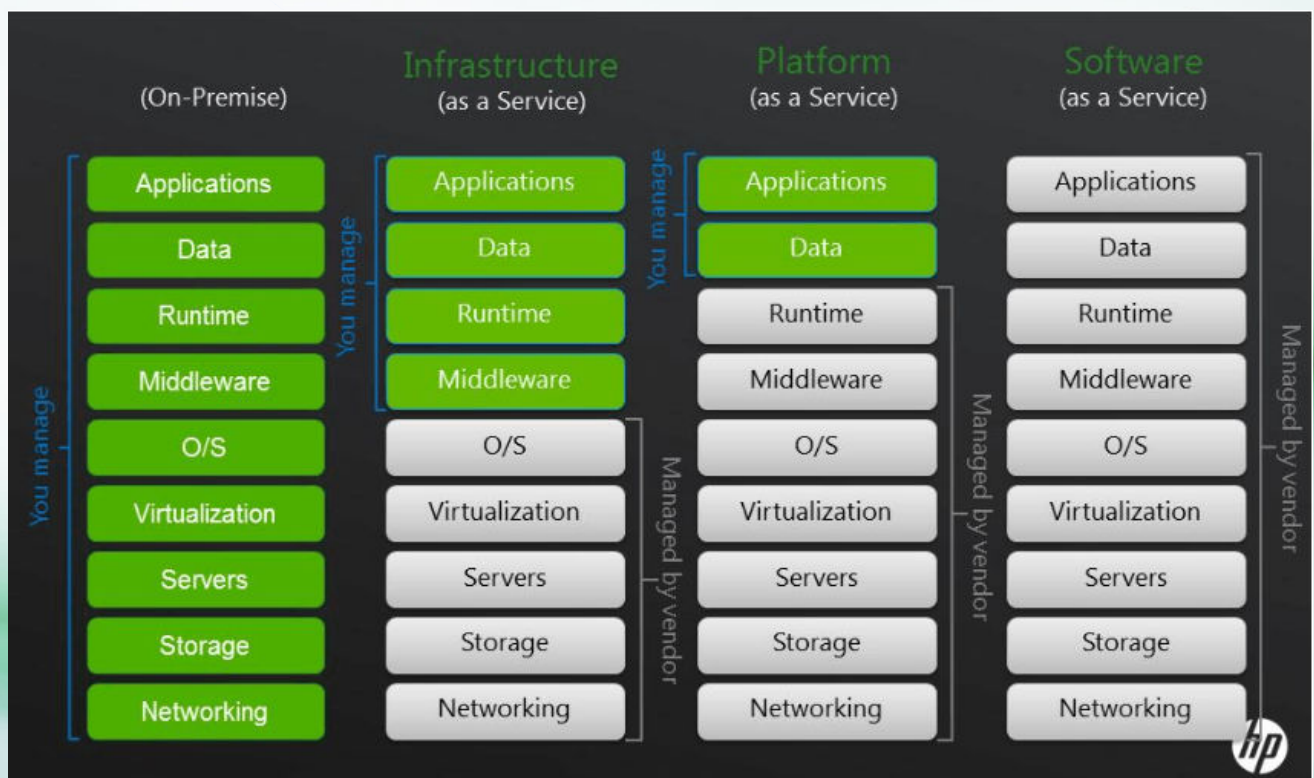

5. 雲端運算為物流及運輸業帶來的好處 (3)

• 雲端運算以達到和「超級電腦」同樣強大的運算效能，可以滿足物流及運輸業的以下需求：

- 實時性 (即時性)
- 排程功能
- 高效能地處理大量數據
- 強大預報的需求



• 雲端的其中一個特點，就是在 Internet 上存在和運作的。它就是一個能容納不同系統的大型網絡系統。因此，雲端物流管理系統必具開放性，能跟其他系統兼容和互動，數據亦可互相傳輸。

6. 物流及運輸業的雲端方案例子

Softlink Logi-Sys www.logisys.in

Register for DEMO

Offline

About Us Solutions Download Enquiry Form Partners Contact Info

Multiple Location, Multiple Operations, One Solution, Logi-Sys.

Logi-Sys integrates your activities like Air Freight, Sea Freight, Warehousing, Transportation, Sales & Service, and Financial Accounting across branches.

SOLUTIONS

- > Freight Forwarding
 - Air Freight
 - Sea Freight
- > Sales & Services
- > Billing
- > Financial Accounting
- > Customs Clearing (India)
- > Customs Compliance (USA)
- > Transportation
- > Warehouse
- > P O Management

FEATURES

Solutions > Features

Logi-Sys is a cutting edge .Net Web based application with SQL database and enterprise class architecture which provides a fully integrated out of the box solution to a logistic service provider serving following business needs.

Cloud (Web) Application

Logi-Sys with its On-Demand web based model reduces IT Infrastructure overheads and also frees users from other aspects such as Maintenance & Upgrades, Information Security, Performance, Support and Business Continuity etc. Pay-per-Use subscription model further reduces the cost of usage.

Comprehensive Cloud ERP platform for Logistics Industry

Logi-Sys
Integrate | Control | Empower

DOWNLOAD BROCHURE

GET IN TOUCH

Live Chat

6. 物流及運輸業的雲端方案例子

Logi-Cloud www.logi-cloud.com

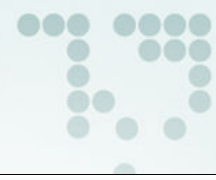

Language 
語言

只需低廉的月費便可擁有專業級物流管理軟件
立即開始使用logi-Cloud雲端系統



LEAVE
A MESSAGE

立即聯絡 +852 2699 9920

logi-cloud - 專門為提昇各種物流相關的業務操作而設計的雲端軟件平台

主頁

為何要用logi-Cloud

模塊介紹

服務

疑問解答

價格

成功案例

過往獎項



最新消息

 3PL-TOTAL發佈最新版
本TMS-total;
3PL-TOTAL Launch
new release of
TMS-total
October 28, 2014

 Announcement on
New Linux ShellShock
Vulnerability
September 29, 2014

 Let's know more
about logo-Cloud
May 5, 2014

6. 物流及運輸業的雲端方案例子

e Logistics Management System

http://www.pccwsolutions.com/public_chi/IT%20Services/Cloud%20Computing%20Services/Enterprise%20Solutions%20Superstore/eLogistics%20Management%20System/



与您携手迈向成功 ENG

关于电讯盈科企业方案 IT服务 业务流程与技术服务 行业解决方案 新闻中心 招聘

云计算服务

首页 > IT服务 > 云计算服务 > 云端企业解决方案市场 > 电子物流管理系统 (eLMS)

搜索

电子物流管理系统 (eLMS)

服务概述

电子物流管理系统 (eLMS) 旨在控制货物在仓库的移动和存储以及相关交易, 如运输、收货、上架和分拣。系统可根据货物箱使用情况的实时信息管理和优化仓库上架。通过整合电子物流管理系统与条码、无线射频识别系统、云计算和移动设备技术, 所有的库存和交易数据能够与中央数据库自动保持同步。

特点

采用我们的电子物流管理系统意味着实时库存交易数据高效率 and 效果的得到控制, 电子物流管理系统还具备以下特点:

- 通过快速和多种可读性的无线射频识别系统, 改进货物收发效率
- 有效的工作安排和计划将工作分成多个任务, 实现更好地资源分配

6. 物流及運輸業的雲端方案例子

Logfire <http://logfire.com/wms/>

LOGFIRE

Cloud-Based WMS

LOGFIRE CLOUD-BASED SOLUTIONS

WAREHOUSE MANAGEMENT SYSTEM (WMS)

Inventory & Warehouse Management Systems

Traditional licensed solutions require substantial up-front investments to cover hardware costs, expensive software, database and infrastructure license fees, heavy consulting fees for long and expensive consulting engagements with high priced consultants, ongoing IT support cost, and annual maintenance fees. And because of the extent of the modifications made to implement traditional WMS system, they are among the least updated systems – falling behind the requirements of the ever-evolving business or that of your competition – and often costing “more than 50% of post implementation total cost of ownership (TCO) to support the WMS modifications”. (Source: Gartner, “Consider These Critical Issues When Evaluating Warehouse Management Systems” by C. Dwight Klappich, 8 December 2011) Beyond the high up-front costs, with traditional highly customized systems, they become difficult, risky, and costly to maintain and upgrade – that is, if you are even able to consider taking advantage of updates versus a complete rip and replacement, because of extensive system modifications. Thus, you are not able to easily leverage ongoing innovation and dynamically adapt to business changes with a traditional solution, whether installed on-premise or hosted by someone else.

LogFire provides a different approach. LogFire Cloud-based Solutions, leveraging our deep domain expertise and managed services offerings, are based on a cost effective multi-tenant infrastructure and a Software-as-a-Service (SaaS) pricing model which includes all cloud-based infrastructure, the LogFire

LET'S TALK
CUSTOMER SUPPORT
REQUEST A DEMO
KEY EVENTS
DOWNLOAD MATERIALS

Follow Us

t in f YouTube

6. 物流及運輸業的雲端方案例子

Shipwire <http://www.shipwire.com/>

Shipwire

SUPPORT RESOURCES SIGN UP LOG IN

Why Shipwire? How It Works Our Pricing Contact Us

Enterprise logistics for everyone®

Helping you deliver with efficiency

See how we can help →
or Get Started Now

Powerful software is at the core of everything we do.

Network of Global Customized for Your Intelligently Directs

6. 物流及運輸業的雲端方案例子 以上5個例子是屬於...?

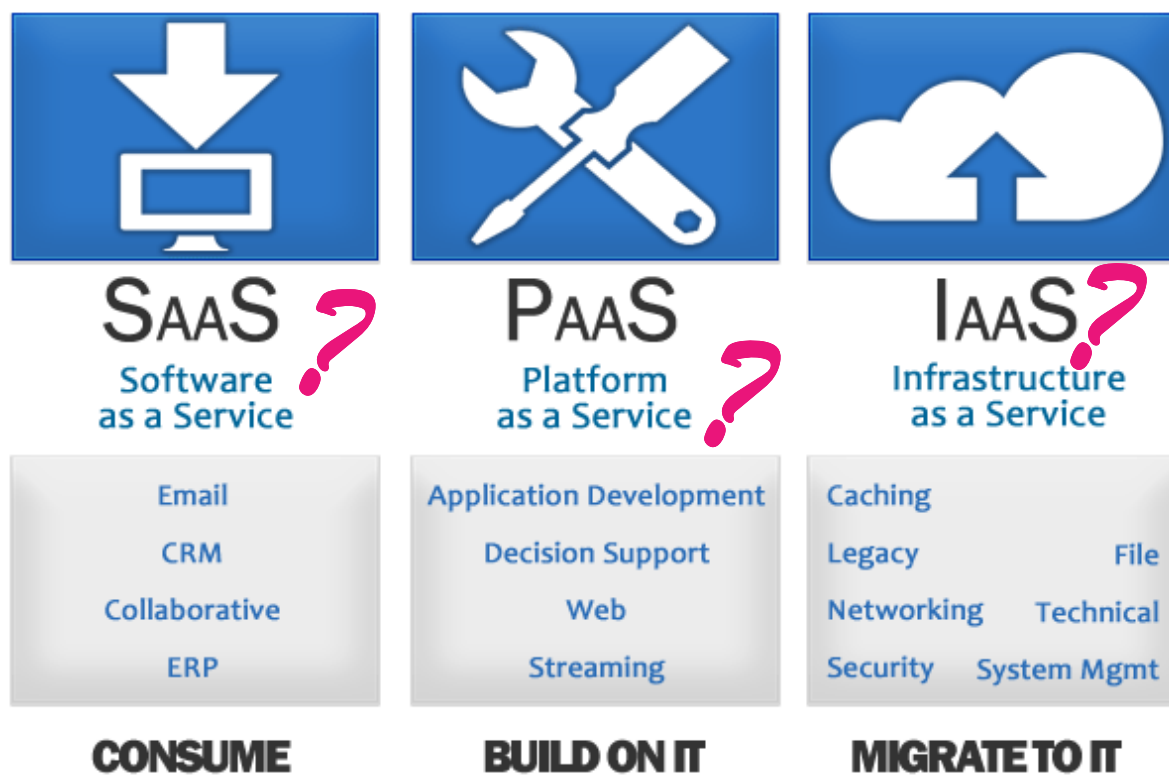

7. 小結

- 已總體的介紹了雲端運算，并略談了物流及運輸業對雲端服務的需要。
- 發現雲端運算對此業界的推動和幫助，是非常有效益及適合的。
- 下一講開始將更具體的闡譯兩者的關係和實施的方方面面。
- 更會介紹相關的方案和系統。如：
 - Softlink Logi-Sys www.logisys.in
 - Logi-Cloud www.logi-cloud.com
 - ...等等

答問時間
課堂完畢
謝謝!!

.....待續

參考資料 (1)

Kris Jamsa – *Cloud Computing*, (Jones & Bartlett Learning, 2013) ISBN 978-1-4496-4739-1

文杰、陳小軍及其團隊 – 雲端運算與 部署應用, (清華大學出版社, 2012) ISBN 978-986-2573-40-2

<http://www.computerweekly.com/feature/A-history-of-cloud-computing>

<http://www.iiiedu.org.tw/south/menu/portal/Cloud-series.htm>

<http://www.ectimes.org.tw/Shownews.aspx?id=101205174623>

<http://www.business.qld.gov.au/business/running/technology-for-business/cloud-computing-business/cloud-computing-benefits>

<http://www.itproportal.com/2013/09/20/top-5-latest-trends-in-cloud-computing/>

<http://www.authorstream.com/Presentation/mikejf12-1870683-introduction-big-data/>

<http://www.unitasglobal.com/cloud-academy-what-is-cloud.html>

參考資料 (2)

Ian Massingham – *AWS 101 (Welcome!)*, (amazon web services, 2014)

谷漢文 – 企業物流管理創新, (中國物資出版社, 2009) ISBN 978-7-5047-3155-5

<http://www.computerweekly.com/feature/A-history-of-cloud-computing>

<http://wiki.mbalib.com/wiki/物流學>

<http://www.networkworld.com/supp/2012/enterprise6/120312-ecs-hybrid-cloud-264443.html?page=4>

<http://www.infocloud.gov.hk/home/1>

<http://www.cs.kent.edu/~jin/Cloud12Spring/BigData.pptx>

<http://www.nhu.edu.tw/~society/e-j/86/13.htm>